

CYLINDER 2 LVS FIXED SUSPENDED MOUNT

Highlight art, objects, places, spaces, seating areas, and architectural details with a classic profile that offers easy-to-adjust, in-field versatility.

PROJECT NAME:	TYPE:
---------------	-------

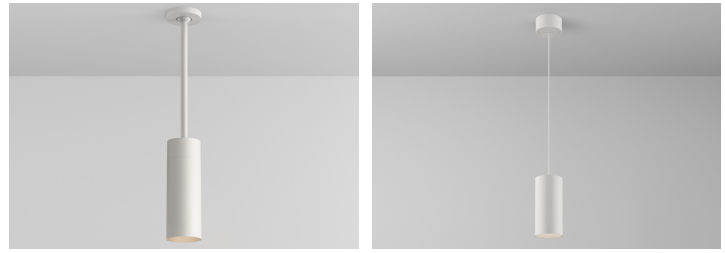

ORDERING INFORMATION - CYLINDER

Quick Ship Product. All rough in components ship within 10 days up to quantities of 100.

CYLINDER	LENGTH	FIXTURE	RATING	CYLINDER FINISH	BAFFLE FINISH	LUMEN PACKAGE	OCT	OPTIC	DRIVER	EFFECTS DEVICE	MOUNTING	
			1						LVS			
Dropkit® STEM ASSEMBLY CD2 3.13"	043 2" - 43" Mechanical Dropkit Stem	FB Fixed Body WW Wallwash Unibody	1 Dry / Damp	WH White AG Satin Silver* AB Architectural Bronze* BK Black CF Custom Finish*	WH White AG Satin Silver* AB Architectural Bronze* BK Black CF Custom Finish*	STATICWHITE 80C12A 80+ CRI FB Dlv. Lumens - 727 80C19A 80+ CRI FB Dlv. Lumens - 1121 WW Dlv. Lumens - 1244 80C25A 80+ CRI FB Dlv. Lumens - 1488 WW Dlv. Lumens - 1699 90C10A 90+ CRI FB Dlv. Lumens - 601 WW Dlv. Lumens - 691 90C15A 90+ CRI FB Dlv. Lumens - 926 WW Dlv. Lumens - 1066 90C20A 90+ CRI FB Dlv. Lumens - 1230 WW Dlv. Lumens - 1456 97C09A 97+ CRI FB Dlv. Lumens - 548 WW Dlv. Lumens - 618 97C14A 97+ CRI FB Dlv. Lumens - 845 WW Dlv. Lumens - 905 97C19A 97+ CRI FB Dlv. Lumens - 1121 WW Dlv. Lumens - 1166	22 2200K* *(Only available for 90+ CRI) 27 2700K 30 3000K 35 3500K 40 4000K	10 10°* *(Only available for 80C12A, 90C10A, and 97C09A. Not available for 2200K) 15 15° 25 25° 40 40° 60 60° WW Wall wash* *(Required and only available for WW fixture)	LVS Low Voltage System	STANDARD EFFECTS DEVICE 4 Soft Focus Lens N No Lens* *(Standard for 10" optic. Not available for Warm Dim) W Wallwash Lens* *(Required and only available for WW fixture) ALTERNATE EFFECTS DEVICE 2 Honeycomb Louver* *(Not available for Warm Dim) 3 Clear Glass Lens* *(Not available for Warm Dim) 5 Frosted Glass Lens 6 Frosted Soft Focus Lens 7 Frosted Linear Spread Lens S Soft Focus Lens w/ Linear Spread Film C Clear Glass Lens w/ Linear Spread Film	ROUGH-IN JBMP 4" Sq. or 4/0 Junction Box Mounting Plate FINISH OUT SMK3 3/0 Surface Mount Kit SMK4 4/0 Surface Mount Kit CMJB 1/2" and 3/4" Conduit Ceiling Mount Junction Box* *(Not available for MA finish. Quick Ship Product for WH and BK finishes only)	
	086 45" - 86" Mechanical Dropkit Stem											
	129 88" - 129" Mechanical Dropkit Stem											
	172 131" - 172" Mechanical Dropkit Stem											
	*All lengths are field cuttable											
PENDANT CP2 3.13"	XXXB Black Cable XXXW White Cable Specify cable length in whole inches (Max 180) ex. specify 006B for a 6 inch black cable* *(Cable is field cuttable)	FB Fixed Body	1 Dry / Damp	WH White AG Satin Silver* AB Architectural Bronze* BK Black MA Machined Aluminum* *(Not available with 9D, 9S, or Wet location) CF Custom Finish*	BK Black	WARM DIM 90W11A 90+ CRI, Incandescent Profile AD / 9D / AS / 9S Dlv. Lumens - 931 WW Dlv. Lumens - 686 90W12A 90+ CRI, Standard Profile AD / 9D / AS / 9S Dlv. Lumens - 1047 WW Dlv. Lumens - 771 *SEE PAGE 3 FOR DETAILED WARM DIM PROFILE COMPARISON. *ALL DELIVERED LUMEN OUTPUTS REFLECT 3000K PAIRED WITH 60° / WW OPTIC AND STANDARD EFFECTS DEVICE.	WL 2700K - 1800K WD 3000K - 1800K	25 25° 40 40° 60 60° WW Wall wash* *(Required and only available for WW fixture)				
	*All delivered lumen outputs reflect 3000K paired with 60° / WW optic and standard effects device.											



PART NUMBER NOTES



- CD2 Adjustable ships as e.g., CY2-AD-1-WH-90C20A2-3-LVS-4
- Stem Assembly ships as CY2-DK-(length)-(finish)
- CP2 ships as e.g., CP2-1-180-WH-90C20A2-3-LVS-4-W
- Mounting ships separate from fixture, part numbers listed on page 8.

CYLINDER 2 LVS FIXED SUSPENDED MOUNT

APPLICATION NOTES

- Lucifer Lighting will not supply a fixture with a POE node or power supply inside the fixture. This allows for easier site install with nodes of 2 or more outputs.
- Consult node manufacturer for maximum remote wiring distances.
- Fixture features 18 Gauge wiring.
- Wiring connections are made on the fixture using customer supplied connectors, ex. wire nuts, push-in connectors, or terminal blocks.
- Confirm node compatibility with factory if it is not listed.
- Customers are responsible for ensuring POE node drive current is set to correct values shown below.
- Customers must ensure voltage range of the proposed POE node encompasses the fixtures complete Vf range, both maximum and minimum. If assistance is required contact LLC rep or factory.

NODE COMPATIBILITY

Manufacturer	Model Number
 Igor® Enabling Smart Buildings™	NP50-60-C-F-5
 molex	180996-1001 180996-1002 180996-2001 180996-2002
 PLATFORMATICS	1 Channel Node, POE-LN2-1U-E 2 Channel Node, POE-LN2-2U-E 4 Channel Node, POE-LN2-4U-E

DRIVE CURRENT SPECIFICS

	80C			90C			97C			90W	
	12A	19A	25A	10A	15A	20A	09A	14A	19A	11A	12A
Minimum Vf	30.5	30.5	30.5	30.5	30.5	30.5	30.5	30.5	30.5	30.5	30.5
Maximum Vf	39	39	39	39	39	39	39	39	39	39	39
Current mA	250	400	550	250	400	550	250	400	550	400	400
Wattage W	8.2	13.6	19.4	8.2	13.6	19.4	8.2	13.6	19.4	13.6	13.6

	10 DEGREE OPTIC		
	80C12A	90C10A	97C10A
Minimum Vf	30.5	30.5	30.5
Maximum Vf	39	39	39
Current mA	400	400	400
Wattage W	13.6	13.6	13.6

WIRING DIAGRAM

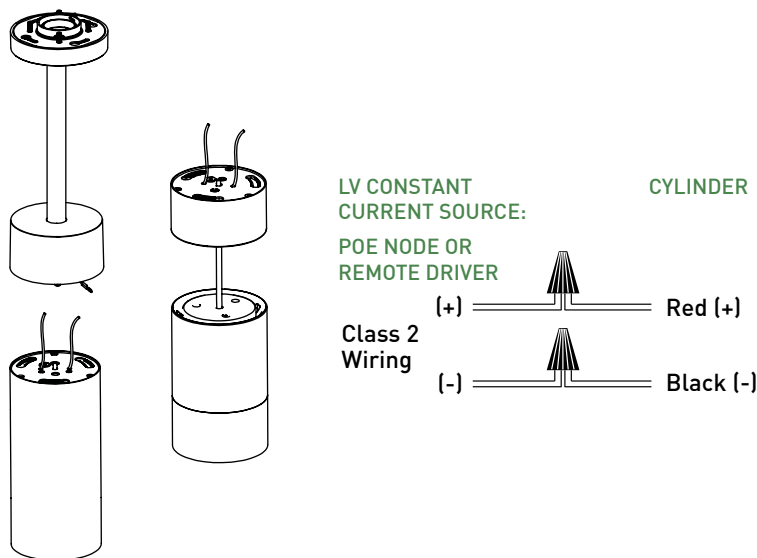

CYLINDER 2 LVS FIXED SUSPENDED MOUNT

ACCESSORIES

FIXED BODY ALTERNATE BAFFLE AND EFFECTS DEVICE

Includes baffle with sealed lens. Must specify baffle finish.

RBA-CY2--HCL** Honeycomb Louver *

*(Not available for Warm Dim)

RBA-CY2--CGL** Clear Glass Lens *

*(Not available for Warm Dim)

RBA-CY2--SFL** Soft Focus Lens

RBA-CY2--FGL** Frosted Glass Lens

RBA-CY2--FSFL** Frosted Soft Focus Lens

RBA-CY2--FLSL** Frosted Linear Spread Lens

RBA-CY2--SFL-LSL** Soft Focus Lens W/ Linear Spread Film

RBA-CY2--CGL-LSL** Clear Glass Lens W/ Linear Spread Film

** Baffle finish: Specify **WH** for white, **BK** for black, **AG** for satin silver or **AB** for architectural bronze.

PENDANT ALTERNATE EFFECTS DEVICES

HCL-CY2-03 Honeycomb Louver *

*(Not available for Warm Dim)

CGL-CY2-03 Clear Glass Lens *

*(Not available for Warm Dim)

SFL-CY2-03 Soft Focus Lens

FGL-CY2-03 Frosted Glass Lens

FSFL-CY2-03 Frosted Soft Focus Lens

FLSL-CY2-03 Frosted Linear Spread Lens

SFL-LSL-CY2-03 Soft Focus Lens W/ Linear Spread Film

CGL-LSL-CY2-03 Clear Glass Lens W/ Linear Spread Film

REPLACEMENT OPTICS

Interchangeable optics accessible by removing snoot or baffle. Not available for Wallwash fixtures.

RO-70-15-1 15° optic *

*(Not available for Warm Dim)

RO-70-25-1 25° optic

RO-70-40-1 40° optic

RO-70-60-1 60° optic

FIXED BODY REPLACEMENT SUCTION TOOL

Included with each CY2-FB order (1 per 10 fixtures).

CY-SQ-TOOL-SUCTION Baffle assembly removal tool

Dropkit STEM EXTENSION

RPS-DK-EXT--**** 2" - 43" Stem Extension

** Stem finish: Specify **WH** for white, **BK** for black, **AG** for satin silver or **AB** for architectural bronze.

CYLINDER 2 LVS FIXED SUSPENDED MOUNT

WALLWASH DESIGN GUIDE



8FT CEILING
36" SETBACK / 48" ON CENTER SPACING



10FT CEILING
36" SETBACK / 48" ON CENTER SPACING



12FT CEILING
36" SETBACK / 48" ON CENTER SPACING



30" SETBACK / 42" ON CENTER SPACING

- AVERAGE FC: 16.06
- MAX / MIN: 6.09
- 10FT CEILING SHOWN / 8-12FT IDEAL
- 7 FIXTURES / 25FT WALL SHOWN



RECOMMENDED

36" SETBACK / 48" ON CENTER SPACING

- AVERAGE FC: 12.89
- MAX / MIN: 6.04
- 10FT CEILING SHOWN / 8-12FT IDEAL
- 7 FIXTURES / 28FT WALL SHOWN

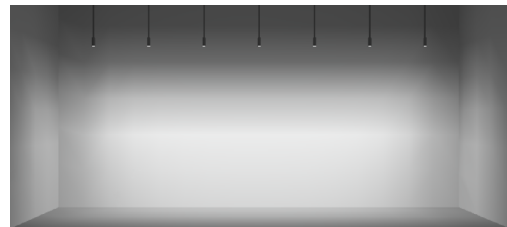

42" SETBACK / 54" ON CENTER SPACING

- AVERAGE FC: 10.39
- MAX / MIN: 7.14
- 10FT CEILING SHOWN / 8-12FT IDEAL
- 7 FIXTURES / 32FT WALL SHOWN

ADDITIONAL SETBACKS AND SPACINGS

ON CENTER SPACING	SETBACK		
	30"	36"	42"
42"	SHOWN ABOVE	AVERAGE FC: 14.44 MAX / MIN: 6.58	AVERAGE FC: 12.87 MAX / MIN: 7.11
48"	AVERAGE FC: 14.34 MAX / MIN: 5.37	SHOWN ABOVE	AVERAGE FC: 11.50 MAX / MIN: 7.00
54"	AVERAGE FC: 12.94 MAX / MIN: 5.83	AVERAGE FC: 11.62 MAX / MIN: 6.30	SHOWN ABOVE

***ALL DATA REFLECTS 90C15A LUMEN PACKAGE**

CYLINDER 2 LVS FIXED SUSPENDED MOUNT

STATIC WHITE PERFORMANCE - 3000K

LUMEN PACKAGE	WATTAGE	10° OPTIC NO SOFT FOCUS LENS		15° OPTIC SOFT FOCUS LENS		25° OPTIC SOFT FOCUS LENS		40° OPTIC SOFT FOCUS LENS		60° OPTIC SOFT FOCUS LENS		WALLWASH WALLWASH LENS	
		DELIVERED	LPW	DELIVERED	LPW	DELIVERED	LPW	DELIVERED	LPW	DELIVERED	LPW	DELIVERED	LPW
80C12A	10	1000	58 (17W)	872	87	739	76	727	73	775	78	807	81
80C19A	17	-	-	1345	80	1139	67	1121	67	1196	71	1244	73
80C25A	24	-	-	1786	75	1513	63	1488	62	1587	67	1699	71
90C10A	10	848	49 (17W)	721	72	611	61	601	60	641	64	691	69
90C15A	17	-	-	1112	66	942	55	926	55	988	59	1066	62
90C20A	24	-	-	1476	62	1251	52	1230	52	1312	55	1456	60
97C09A	10	703	41 (17W)	657	66	557	55	548	55	584	58	618	62
97C14A	17	-	-	1014	61	859	50	845	50	901	54	905	53
97C19A	24	-	-	1346	56	1140	47	1121	47	1196	50	1166	49
90W11A	16	-	-	-	-	901	56	766	47	931	58	758	47
90W12A	16	-	-	-	-	1013	63	861	53	1047	64	852	53

OUTPUT MULTIPLIER	
CCT	CCT SCALE
2200K	0.800
2700K	0.957
3000K	1.000
3500K	1.019
4000K	1.030

LIGHT LOSS FACTOR MULTIPLIER	
No Lens	1.05
SFL	1.00
CGL	1.00
FGL	0.90
FSFL	0.87
FLSL	0.83
SFL W/ LINEAR SPREAD	0.82
CGL W/ LINEAR SPREAD	0.82
HCL	0.65

WARM DIM PERFORMANCE - SOFT FOCUS LENS - 60° OPTIC

STANDARD WARM DIM PROFILE

90W12A 3000K - 1800K	Full on 100%	Dimmed to 80%	Dimmed to 70%	Dimmed to 50%	Dimmed to 20%	Dimmed to 10%	Dimmed to 2%
CCT (K)	3000	2950	2920	2775	2375	2000	1800
Light Output (Lm)	1047	837	732	523	209	104	20
Power (W)	14	11	10	7	3	1.5	0.3
Efficacy (LPW)	64	64	64	64	64	64	64

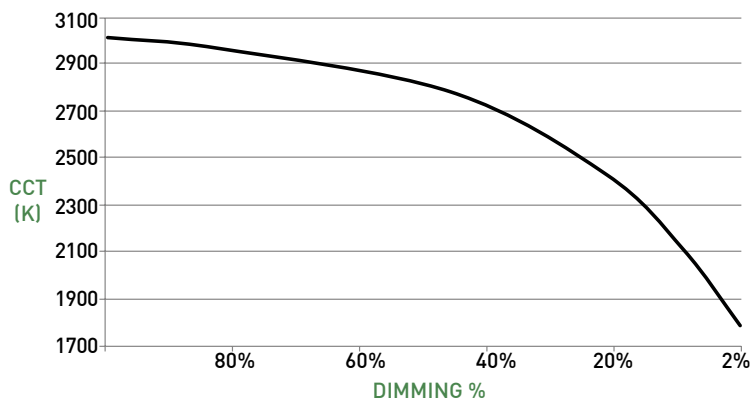

WARM DIM TO MIRROR INCANDESCENT DIMMING PROFILE

90W11A 2700K - 1800K	Full on 100%	Dimmed to 80%	Dimmed to 70%	Dimmed to 50%	Dimmed to 20%	Dimmed to 10%	Dimmed to 2%
CCT (K)	2700	2650	2620	2520	2180	1950	1800
Light Output (Lm)	931	744	651	465	186	93	18
Power (W)	16	13	11	8	3	1.7	0.3
Efficacy (LPW)	58	58	58	58	58	58	58

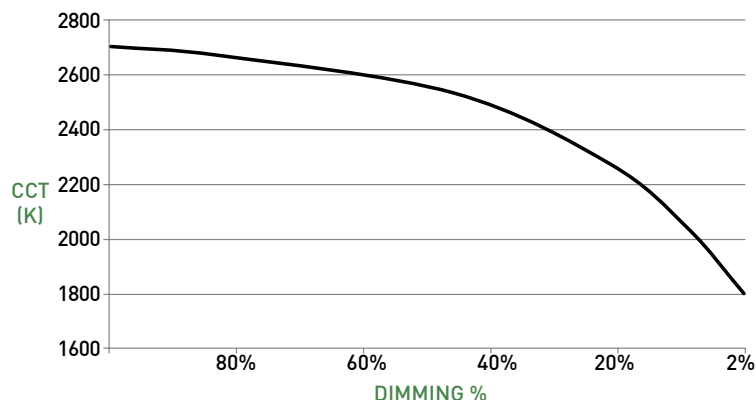

CYLINDER 2 LVS FIXED SUSPENDED MOUNT

Dropkit STEM ASSEMBLY

- A LUMINAIRE**
Body with integrated heat sink and LED. Conceals mounting hardware. Power supply must be remote mount.
- B STANDARD OPTICS**
Proprietary optics available in 10°, 15°, 25°, 40° & 60° beams.
- WALLWASH OPTIC**
Precision tuned optic provides uniform wallwashing effect.
- C EFFECTS DEVICE**
Cylinder baffle assembly can accept 1 lens. Soft focus lens, no lens or wallwash lens standard; lenses sealed in place.
- D BAFFLE**
Baffle minimizes aperture glare and conceals view into fixture. Suction tool provided for removal of CY2-FB baffle.
- E Dropkit**
 - Field cuttable rigid stem for suspending fixture at desired height. Provides stable base to allow preferred fixture tilt, while maintaining vertical stem position.
 - Ball joint allows up to 45° tilt for sloped ceilings and can be locked once stem is positioned vertically.
 - Four 43" sections available; 172" maximum standard length.
 - Length adjustment occurs in lower canopy.
 - Wiring for kit provided by others.

DIMENSIONS / DRAWINGS

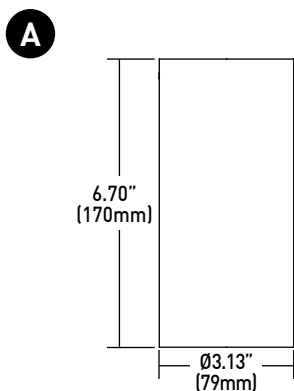

FIXED BODY

WALLWASH UNIBODY

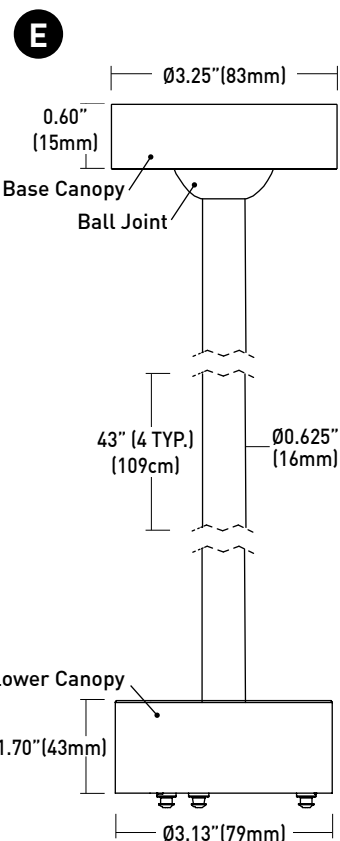
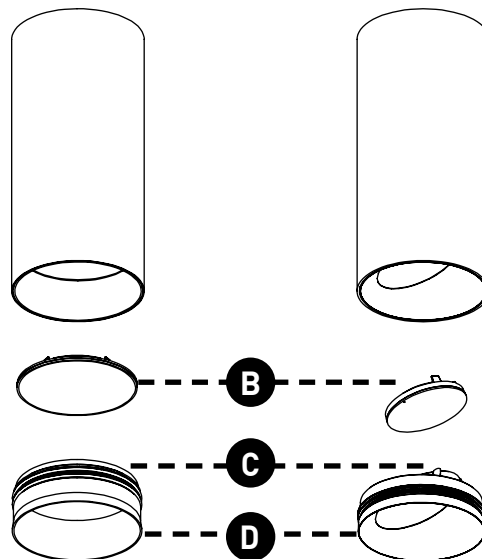

CYLINDER 2 LVS FIXED SUSPENDED MOUNT

PENDANT

- F CANOPY**
Die-cast 1.60" (41mm) canopy accommodates flat and slope ceiling conditions. Conceals hidden twist-on mounting hardware. Power supply must be remote mount.
- G CABLE**
Black and white wiring harness available; up to 180.0" length; cable may be cut in field.
- H LUMINAIRE**
Die-cast body with integral heat sink and LED.
- I OPTICS**
Proprietary optics available in 10°, 15°, 25°, 40° & 60° beams.
- J EFFECTS DEVICE**
Cylinder baffle assembly can accept 1 lens; soft focus lens or no lens standard and sealed in place.
- K BAFFLE**
Threaded removable cowling provides virtually seamless joint with fixture body.

DIMENSIONS / DRAWINGS

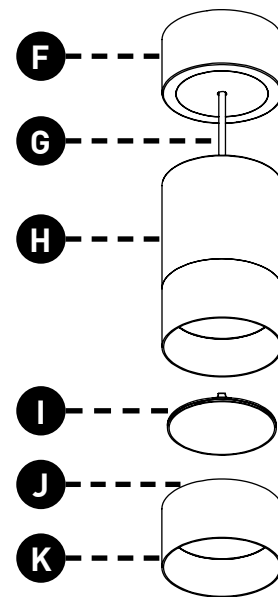
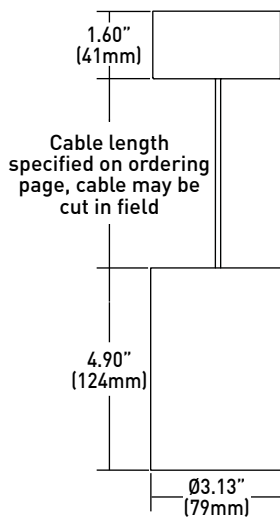

CYLINDER 2 LVS FIXED SUSPENDED MOUNT

Dropkit AND PENDANT MOUNTING

- L JBMP**
Mounting plate (concealed) for standard 4" square or 4" 4/0 j-box . To be installed during rough-in prior to substrate. Fixture to mount flush with minimalist transition to ceiling.
Part Number - CY2/3-JBMP or CD-JBMP
- M SMK3**
Surface mount kit includes mounting plate and 4" concealer plate that installs between fixture and standard 3" 3/0 j-box for existing applications where standard j-box cutout is to be concealed.
Part Number - CY2/3-SMK-3/0-(FINISH) or CD-SMK-3/0-(FINISH)
- N SMK4**
Surface mount kit includes mounting plate and 5" concealer plate that installs between fixture and standard 4" 4/0 j-box for existing applications where standard j-box cutout is to be concealed.
Part Number - CY2/3-SMK-4/0-(FINISH) or CD-SMK-4/0-(FINISH)
- O CMJB**
Ceiling mount junction box perfectly matches the cylinder profile for a continuous, integrated look where exposed ceiling mount junction box and conduit applications apply. For use with 1/2" and 3/4" EMT conduit only. Features two conduit entrances on either side and one conduit knockout on top of j-box. J-box is IP10 rated; painted finishes only. Blank off plugs included.
Part Number - CY2-CMJB-(FINISH) or CD-CMJB-(FINISH)

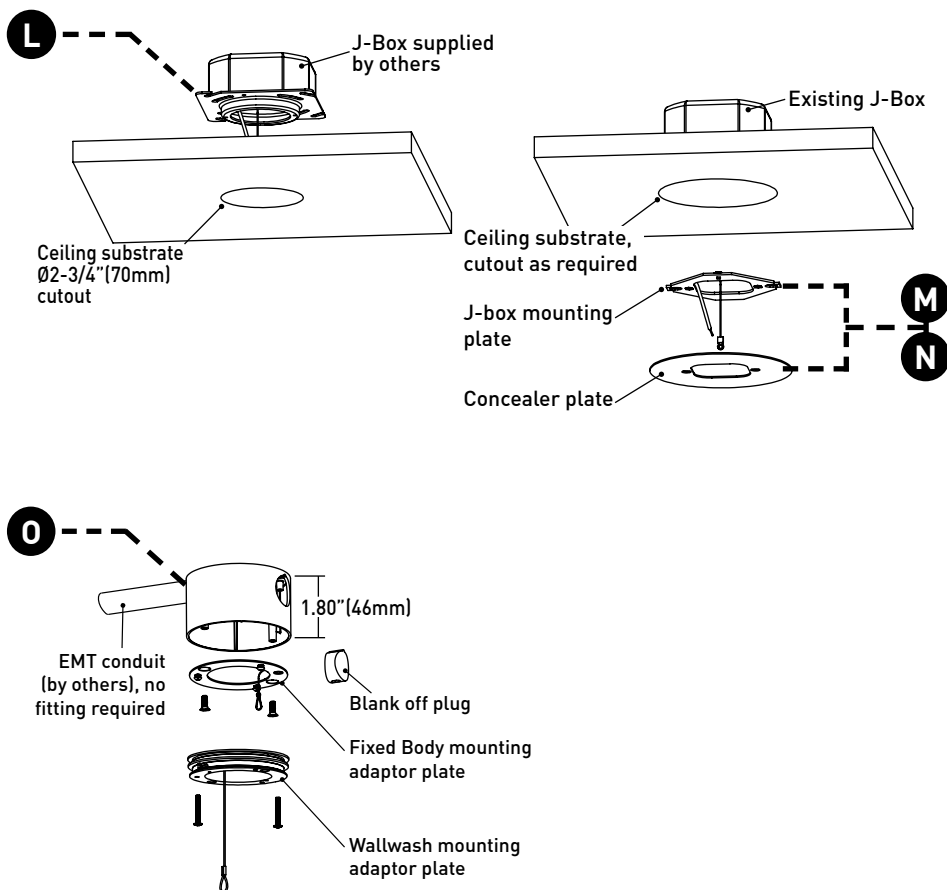

MOUNTING NOTES

- CY2/3-JBMP and CY2/3-SMK-3/0 & 4/0 not recommended for use with pancake style j-box.
- Fixtures are surface mount and must have access to free air. For applications involving slat ceilings or confined mounting, consult Comprehensive Install Guide for required clearances for proper air flow and servicing.

CYLINDER 2 LVS FIXED SUSPENDED MOUNT

TECHNICAL

CONSTRUCTION

Cylinder: Die-cast or Machined aluminum body; extruded aluminum internal heat-sink; painted finishes are granulated powder coat.

Dropkit Stem Assembly: Die-cast aluminum canopies and extruded aluminum stems; painted finishes are granulated powder coat.

CMJB: Die-cast aluminum body; painted finishes are granulated powder coat.

STATIC WHITE LED

2-step MacAdam ellipse LED module available in 80+, 90+ and 97+ CRI configurations in color temperatures of 2200K, 2700K, 3000K, 3500K and 4000K. Average rated lamp life of 50,000 hours. LED and driver assemblies are field-replaceable.

WARM DIM LED

3-step MacAdam ellipse warm dim LED module available in 90+ CRI configuration. 3000K or 2700K at full brightness, warming to 1800K at full dim. Average rated lamp life of 50,000 hours. LED and driver assemblies are field-replaceable.

WALLWASH SPACING

Factory recommends 48" (1219mm) spacing on center with 36" (914mm) setback from wall plane.

MOUNTING

Pendant is supplied with a mounting adaptor plate, which integrates with specified mounting component. Dropkit Stem integrates directly with specified mounting component. Both applications provide a minimalist transition from standard 4/0 or 4" square junction boxes and accommodating ceiling thicknesses of 0.44" (12mm) to 0.75" (19mm). Ceiling-mount junction box available for 1/2" (13mm) and 3/4" (19mm) conduit and feature concealed internal clamps for clean fitting-free conduit exit and entry.

LISTING

cTUVus listed to UL2108 standard for Dry / Damp (IP10) locations.

FIXTURE WEIGHT

CD3 / Mounting - 4.2 lbs

CP3 / Mounting - 3 lbs

LIMITED WARRANTY

Manufacturer's 1-year warranty guarantees product(s) listed to be free from defects in material and workmanship under normal use and service. 5-year warranty on LED to operate with 70% of the original flux and remain within a range of 3 duv. Warranty period begins from the date of shipment by Seller. [Consult website for full warranty terms and conditions.](#)

CHANGE LOG

- 1.01/12/2021: ADDED 2200K, 2700K-1800K WARM DIM AND 10 DEGREE OPTIC OFFERINGS.
- 2.04/27/2021: ADDED LP1 DRIVER OFFERING.
- 3.11/17/2021: UPDATED 25° PHOTOMETRICS.
- 4.06/21/2022: ADDED SOFT FOCUS LENS W/ LINEAR SPREAD FILM, AND CLEAR GLASS LENS W/ LINEAR SPREAD FILM.
- 5.10/17/2022: REMOVED 90W13A 3200K-1800K WARM DIM AND ADDED 90W12A 3000K-1800K WARM DIM.